

Valvole Farfalla  
*Butterfly valves*

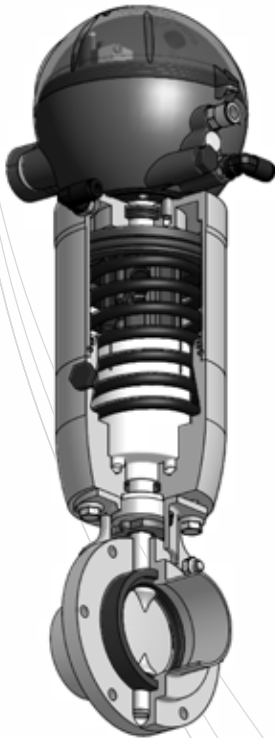

# ZVF **Dati tecnici** *Technical details*

**MACH**



**ZVF**

<b>Struttura valvola</b>		
Conessioni da DN10 a 150	DIN, SMS, IDF, BS (RJT), Clamp, Flangia	Altre connessioni a richiesta
Materiale a contatto con il prodotto	AISI 316L (1.4404)	Altro materiale a richiesta
Materiale guarnizioni a contatto con il prodotto (omologazione FDA)	EPDM, FKM, HNBR	Altro materiale a richiesta
Temperatura massima prodotto (EPDM)	120°C (248°F)	Per temperature diverse contattare Bardiani Valvole
Temperatura minima prodotto (EPDM)	-10°C (14°F)	
Pressione massima prodotto	10bar (145psi)	
Pressione minima di tenuta	Vuoto	
Finitura superficiale materiale a contatto con il prodotto	Ra0.8µm (altri tipi di finitura a richiesta)	
<b>Struttura attuatore pneumatico</b>		
Attacchi aria	1/8" (BSP) per tubo 6x4mm	
Pressione	Da 6bar (87psi) a 8bar (116psi)	
Materiale cilindro	AISI 304 (1.4301)	
Materiale guarnizioni	NBR	
<b>Comando manuale</b>		
Materiale maniglia	Plastica (PA6 GF30)	AISI 304 (1.4301) su richiesta

<b>Valve structure</b>		
<i>Connections from DN10 to DN150</i>	<i>DIN, SMS, IDF, BS (RJT), Clamp, Flange</i>	<i>Other connections on request</i>
<i>Material in contact with the product</i>	<i>AISI 316L (1.4404)</i>	<i>Other material on request</i>
<i>Material gaskets in contact with the product (FDA homologation)</i>	<i>EPDM, FKM, HNBR</i>	<i>Other material on request</i>
<i>Max. product temperature (EPDM)</i>	<i>120°C (248°F)</i>	<i>For higher temperature, please ask Bardiani Valvole</i>
<i>Min. product temperature (EPDM)</i>	<i>-10°C (14°F)</i>	
<i>Max. product pressure</i>	<i>10bar (145psi)</i>	
<i>Min. working pressure</i>	<i>Full vacuum</i>	
<i>Finish on surfaces in contact with the product</i>	<i>Ra0.8µm (other types of surface finish on request).</i>	
<b>Pneumatic actuator specifications</b>		
<i>Air connectors</i>	<i>1/8" (BSP) for pipe 6x4mm</i>	
<i>Air pressure</i>	<i>From 6bar (87psi) to 8bar (116psi)</i>	
<i>Cylinder material</i>	<i>AISI 304 (1.4301)</i>	
<i>Gasket material</i>	<i>NBR</i>	
<b>Hand control</b>		
<i>Handle material</i>	<i>Plastic (PA6 GF30)</i>	<i>AISI 304 (1.4301) on request</i>



## Soluzioni varie *Different solutions*

# ZVF

### Comando manuale

Disponibile nelle versioni in plastica oppure su richiesta in acciaio inox. Affidabile ed estremamente flessibile. La valvola manuale farfalla VVF sfrutta tutta la componentistica della valvola ZVF, tranne la parte pneumatica.

#### **Hand control**

*Available in plastic or stainless steel (upon request). Reliable and extremely flexible. the VVF manual valve uses all the parts from the ZVF valve apart from the pneumatic components.*

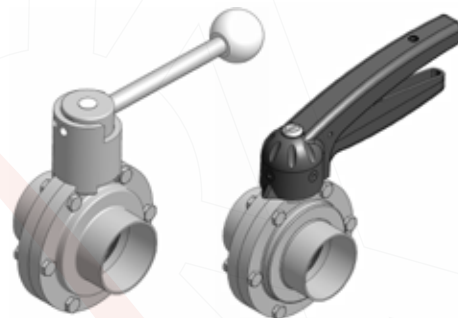

### Valvola farfalla-WAFER

Questa tipologia di attacchi, disponibili per la linea delle valvole farfalla, è stata progettata con l'obiettivo di semplificare la rimozione della valvola dalla linea di tubazione durante le operazioni di manutenzione.

#### **Butterfly WAFER valve**

*This particular type has been engineered to allow an easy way to dismantle the butterfly valves from the pipeline.*

### Sensori per VVF

L'applicazione di uno o due proximity consente di segnalare la posizione della valvola in fase di apertura e di chiusura.

#### **VVF Proximities**

*One or two Proximity switches can be installed close to the lever; a feedback is given to an electrical board.*

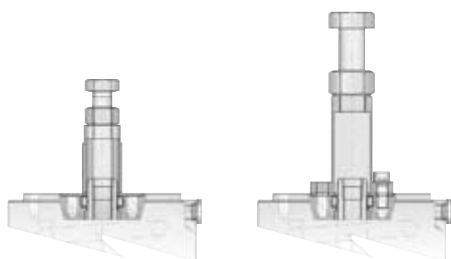

### Limitatore di corsa

Accessorio che consente la regolazione meccanica dell'escursione della valvola.

#### **Stroke limiter**

*Adjustable device which allows for a mechanical limitation of valve stroke.*

### Esecuzioni speciali su richiesta

Ogni accessorio è disponibile su richiesta del cliente per tutti i diametri e tutte le configurazioni corpi valvola. E' inoltre possibile la personalizzazione di attacchi, diametri oppure soluzioni non presenti a catalogo. Bardiani Valvole consiglia di consultare sempre l'ufficio tecnico in fase d'ordine per ulteriori informazioni e studi di fattibilità.

#### **Special options and variation on request**

*On request most accessories are available for all sizes of valve and body configurations. Additionally special ports, diameters and other tailor-made solutions are available. Bardiani Valve can also provide technical support, advice and feasibility analysis for other requests.*

# ZVF

Dimensioni (mm)  
Dimensions (mm)

## SALDARE / WELD DIN

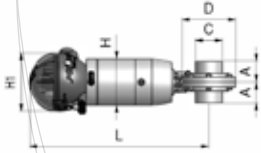

DN	A	B	C	D	E	H	H1	L
10	30	97	12x1	62	160	90	112	323
15	30	97	18x1	62	160	90	112	323
20	32	106	22x1.5	80	160	90	112	331
25	32	107	28x1.5	80	160	90	112	331
32	34	109	34x1.5	85	160	90	112	333
40	35	112	40x1.5	92	160	90	112	337
50	40	118	52x1.5	104	160	90	112	343
65	43	129	70x2	125	160	105	112	356
80	36	137	85x2	142	160	105	112	364
100	36	147	101.6x2	162	160	105	112	374
125	56	161	132x3.5	200	220	168	145	491
150	62	176	157x3.5	230	220	168	145	504

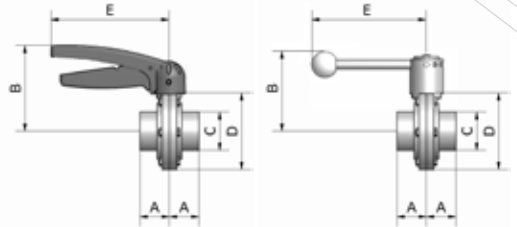

## SALDARE / WELD DIN11850/2

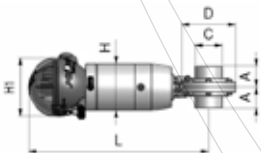

DN	A	B	C	D	E	H	H1	L
10	30	97	13x1.5	62	160	90	112	323
15	30	97	19x1.5	62	160	90	112	323
20	32	106	23x1.5	80	160	90	112	331
25	32	107	29x1.5	80	160	90	112	331
32	34	109	35x1.5	85	160	90	112	333
40	35	112	41x1.5	92	160	90	112	337
50	40	118	53x1.5	104	160	90	112	343
65	43	129	70x2	125	160	105	112	356
80	36	137	85x2	142	160	105	112	364
100	36	147	104x2	162	160	105	112	374
125	56	161	129x2	200	220	168	145	491
150	62	176	154x2	230	220	168	145	504

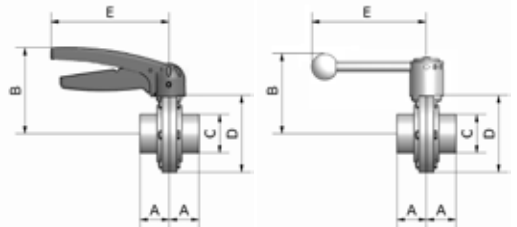

## FEMMINA / MALE DIN

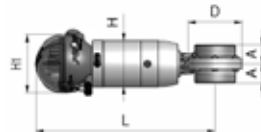

DN	A	B	D	E	H	H1	L
10	34	97	62	160	90	112	323
15	34	97	62	160	90	112	323
20	35	106	80	160	90	112	331
25	35	107	80	160	90	112	331
32	36	109	85	160	90	112	333
40	35	112	92	160	90	112	337
50	37	118	104	160	90	112	343
65	41	129	125	160	105	112	356
80	46	137	142	160	105	112	364
100	47	147	162	160	105	112	374
125	56	161	200	220	168	145	491
150	62	176	230	220	168	145	504

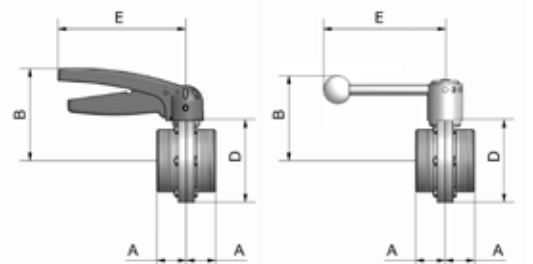

## MASCHIO+GIRELLA / LINER+NUT DIN

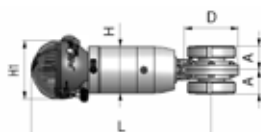

DN	A	B	D	E	H	H1	L
10	-	-	-	-	-	-	-
15	35	97	62	160	90	112	323
20	38	106	80	160	90	112	331
25	38	107	80	160	90	112	331
32	41	109	85	160	90	112	333
40	41	112	92	160	90	112	337
50	46	118	104	160	90	112	343
65	50	129	125	160	105	112	356
80	57	137	142	160	105	112	364
100	70	147	162	160	105	112	374
125	90	161	200	220	168	145	491
150	99	176	230	220	168	145	504

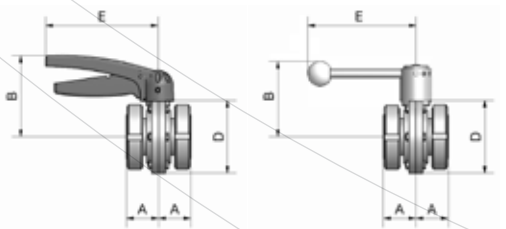

### Legenda / Key

- Su richiesta/On demand

Dimensioni (mm)  
Dimensions (mm)

ZVF

FLANGIA /  
FLANGE PN10

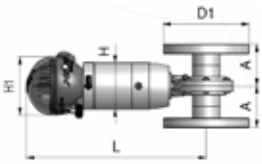

DN	A/A1	A2	B	D1	E	H	H1	L
10	-	-	-	-	-	-	-	-
15	-	-	-	-	-	-	-	-
20	-	-	-	-	-	-	-	-
25	71	204	107	115	160	90	112	331
32	75	206	109	140	160	90	112	333
40	76	206	112	150	160	90	112	337
50	80/50	208	118	165	160	90	112	343
65	84/54	208	129	185	160	105	112	356
80	82/52	210	137	200	160	105	112	364
100	84	212	147	220	160	105	112	374

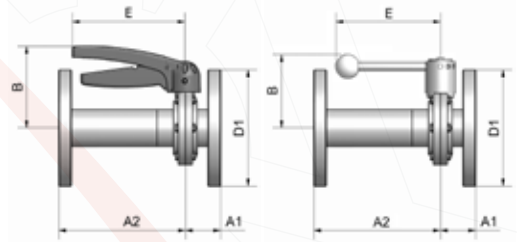

SALDARE / WELD INCHES

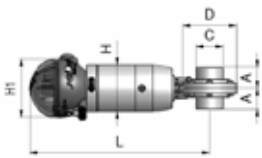

DN	A	B	C	D	E	H	H1	L
1"	26	107	25.4x1.5	80	160	90	112	331
1 1/2"	25	109	38.1x1.5	92	160	90	112	337
2"	27	112	50.8x1.5	104	160	90	112	343
2 1/2"	28	126	63.5x1.5	120	160	105	112	356
3"	30	131	76.1x2	130	160	105	112	364
4"	36	147	101.6x2	162	160	105	112	374
5"	56	161	127x2	200	220	168	145	491
6"	62	176	152.4x2	230	220	168	145	504

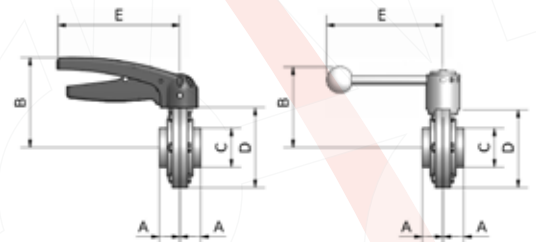

CLAMP

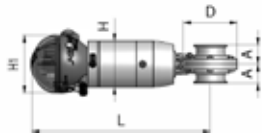

DN	A	B	D	E	H	H1	L
1"	35	107	80	160	90	112	331
1 1/2"	35	109	92	160	90	112	337
2"	37	112	104	160	90	112	343
2 1/2"	41	126	120	160	105	112	356
3"	43	131	130	160	105	112	364
4"	51.5	147	162	160	105	112	374
5"	-	-	-	-	-	-	-
6"	-	-	-	-	-	-	-

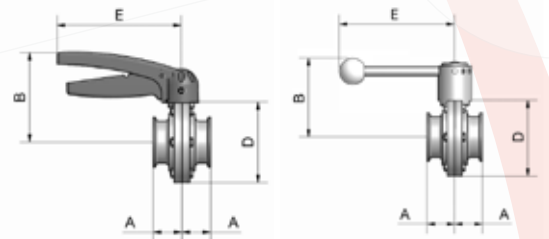

FEMMINA / MALE ISO

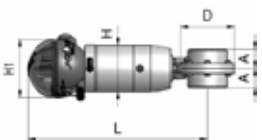

DN	A	B	D	E	H	H1	L
1"	35	107	80	160	90	112	348
1 1/4"	35	107	85	160	90	112	351
1 1/2"	35	109	92	160	90	112	356
2"	37	112	104	160	90	112	364
2 1/2"	41	126	125	160	105	112	375
3"	41	131	142	160	105	112	384
4"	43	147	162	160	105	112	394

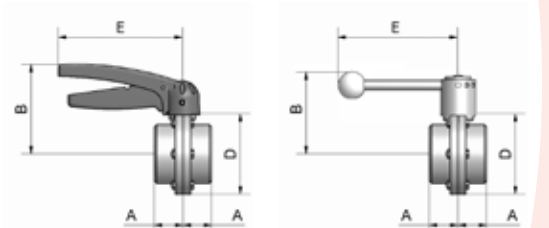

FEMMINA / MALE SMS

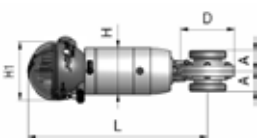

DN	A	B	D	E	H	H1	L
1"	35	107	80	160	90	112	331
1 1/2"	37	109	92	160	90	112	337
2"	39	112	104	160	90	112	343
2 1/2"	52	126	120	160	105	112	356
3"	54	131	130	160	105	112	364
4"	61	147	162	160	105	112	374

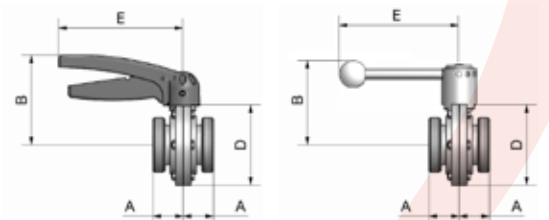

Legenda / Key

- Su richiesta/On demand

# ZVF

Dimensioni (mm)  
Dimensions (mm)

## FEMMINA / MALE IDF

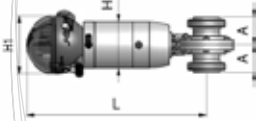

DN	A	B	D	E	H	H1	L
1"	47.5	107	80	160	90	112	331
1 1/2"	46.5	109	92	160	90	112	337
2"	48.5	112	104	160	90	112	343
2 1/2"	49.5	126	120	160	105	112	356
3"	51.5	131	130	160	105	112	364
4"	57.5	147	162	160	105	112	374

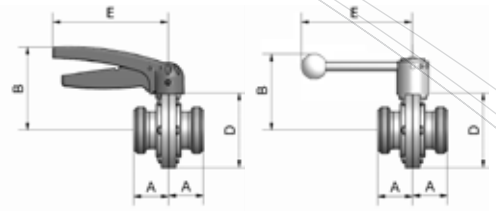

## FEMMINA / MALE BS (RJT)

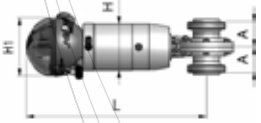

DN	A	B	D	E	H	H1	L
1"	47.5	107	80	160	90	112	331
1 1/2"	46.5	109	92	160	90	112	337
2"	48.5	112	104	160	90	112	343
2 1/2"	49.5	126	120	160	105	112	356
3"	51.5	131	130	160	105	112	364
4"	57.5	147	162	160	105	112	374

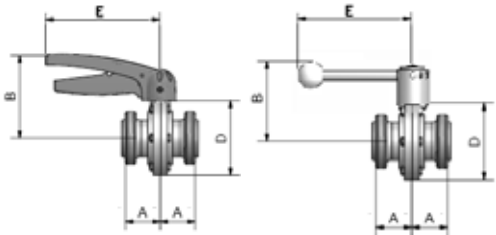

## WAFFER DIN

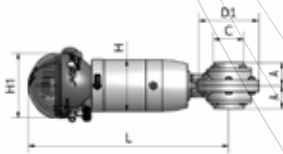

DN	A	B	C	D1	E	H	H1	L
10	-	-	-	-	-	-	-	-
15	40	97	18x1	62	160	90	112	323
20	-	-	-	-	-	-	-	-
25	40	107	28x1.5	80	160	90	112	331
32	40	109	34x1.5	85	160	90	112	333
40	40	112	40x1.5	92	160	90	112	337
50	40	118	52x1.5	104	160	90	112	343
65	40	129	70x2	125	160	105	112	356
80	47	137	85x2	142	160	105	112	364
100	49	147	101.6x2	162	160	105	112	374
125	58	161	129x2	200	220	168	145	491
150	70	176	154x2	230	220	168	145	504

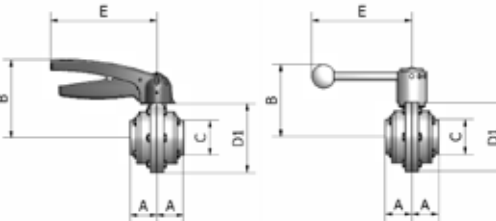

## WAFFER DIN 11850/2

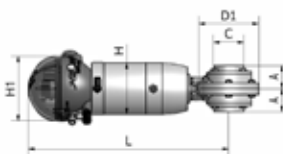

DN	A	B	C	D1	E	H	H1	L
10	-	-	-	-	-	-	-	-
15	40	97	19x1.5	62	160	90	112	323
20	-	-	-	-	-	-	-	-
25	40	107	29x1.5	80	160	90	112	331
32	40	109	35x1.5	85	160	90	112	333
40	40	112	41x1.5	92	160	90	112	337
50	40	118	53x1.5	104	160	90	112	343
65	40	129	70x2	125	160	105	112	356
80	47	137	85x2	142	160	105	112	364
100	49	147	104x2	162	160	105	112	374
125	58	161	129x2	200	220	168	145	491
150	70	176	154x2	230	220	168	145	504

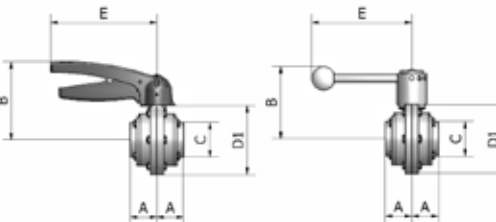

## WAFFER INCHES

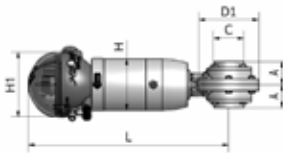

DN	A	B	C	D1	E	H	H1	L
1"	40	107	25.4x1.5	80	160	90	112	331
1 1/2"	40	112	38.1x1.5	92	160	90	112	337
2"	40	118	50.8x1.5	104	160	90	112	343
2 1/2"	40	129	63.5x1.5	120	160	105	112	356
3"	45	137	76.1x2	130	160	105	112	364
4"	49	147	101.6x2	162	160	105	112	374
5"	58	161	127x2	200	220	168	145	491
6"	70	176	152.4x2	230	220	168	145	504

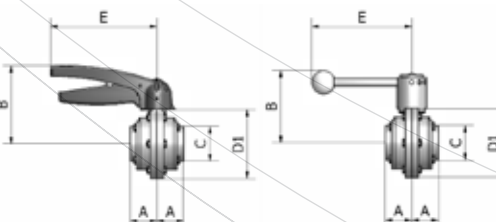

### Legenda / Key

-	Su richiesta/On demand
---	------------------------

Dimensioni (mm)  
Dimensions (mm)

ZVF

**Dimensioni attuatore pneumatico MACH per valvola Farfalla**  
**Dimensions of pneumatic actuator MACH for Butterfly valve**

MACH 83-98

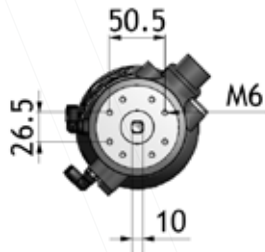

MACH 156

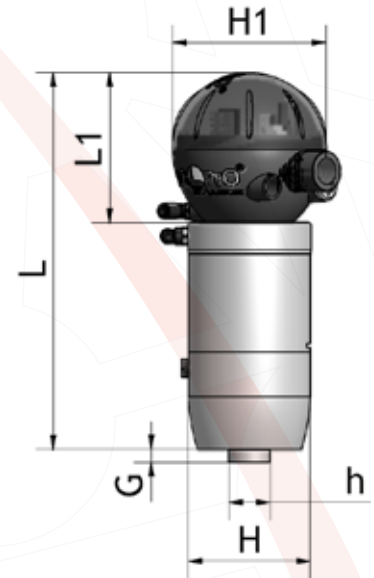
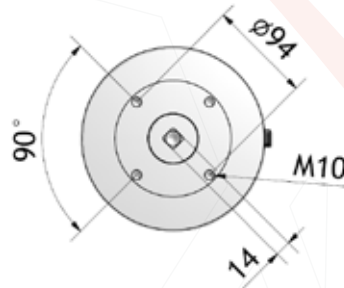

	G	H	H1	h	L	L1
83 SE - DE	10	90	112	30	275	109
98 SE - DE	10	105	112	30	275	109
156 SE - DE	16	168	145	45	370	128

Legenda / Key	
SE	Semplice Effetto / <i>Single acting</i>
DE	Doppio Effetto / <i>Double Acting</i>
83 - 98 - 156	Diametro attuatore / <i>Actuator diameter</i>

Per maggiori informazioni contattare l' ufficio tecnico  
For more information please contact our technical office

# ZVF

Pesi (KG)  
Weights (KG)

Valvole a farfalla manuali - Manual butterfly valves								
DN	S/S	F/F	F/S	F/M	M/S	M/M	CLAMP	WAFER
25 - 1"	0.95	1.2	1.1	1.3	1.2	1.45	1.2	
32	1.05	1.35	1.2	1.5	1.35	1.65	-	
40 - 1" 1/2	1.15	1.55	1.35	1.65	1.5	1.9	1.3	
50 - 2"	1.45	1.95	1.7	2.2	1.95	2.4	1.6	
65 - 2" 1/2	2.05	2.8	2.4	3.2	2.85	4.5	1.8	
80 - 3"	2.85	3.9	3.4	4.5	3.95	5.05	2.5	
100 - 4"	3.8	4.6	4.15	5.8	5.4	7.05	4.2	
Valvole a farfalla pneumatiche - Pneumatic butterfly valves								
DN	S/S	F/F	F/S	F/M	M/S	M/G	CLAMP	WAFER
25 - 1"	4.6	4.85	4.75	4.95	4.85	5.1	4.8	
32	4.7	5	4.85	5.15	5	5.3	-	
40 - 1" 1/2	4.8	5.2	5	5.3	5.15	5.55	5	
50 - 2"	5.1	5.6	5.35	5.85	5.6	6.05	5.3	
65 - 2" 1/2	6.95	7.7	7.3	8.1	7.75	8.5	6.7	
80 - 3"	7.8	8.85	8.35	9.45	8.9	10	7.3	
100 - 4"	8.75	9.55	9.1	10.75	10.35	12	9	

## Nota bene

- I pesi indicati sopra si riferiscono alla configurazione standard: attuatore a semplice effetto (solo valvole pneumatiche).
- Verificare sempre il peso della relativa unità di controllo Giotto Top abbinata alla singola valvola.
- I pesi indicati hanno valore puramente indicativo.

Legenda / Key	
S/S	Saldare - Welding
F/F	Femmina - Male
F/S	Femmina/saldare - Male/welding
F/M	Femmina/Maschio + girella - Male/Liner + nut
M/S	Maschio + girella/saldare - Liner + nut/Welding
M/G	Maschio + girella - Liner + nut
CLAMP	Clamp
WAFER	Wafer
-	Su richiesta/On demand

## Take note

- Above weights refer to standard configurations: simple acting actuator (pneumatic valves only).
- Please check the weight of the "Giotto Top" valve control unit
- Above weights have pure indicative values.



## Raccomandazioni

1. Tutte le affermazioni, le indicazioni e le notizie tecniche qui riportate sono basate sui dati di prove che riteniamo attendibili, ma non riferibili ad ogni possibile utilizzo del prodotto. Dal momento che le condizioni d'uso e di applicazione sono al di fuori del nostro controllo, l'Acquirente deve preventivamente accertare l'idoneità del prodotto all'uso al quale intende destinarlo, assumendo ogni rischio e responsabilità derivante dall'uso stesso. Bardiani Valvole S.p.A. non si assume responsabilità per alcun incidente, perdita o danno, diretto o consequenziale derivante dall'uso o dall'impossibilità d'uso del prodotto. Nessuno è autorizzato a concedere garanzie maggiori o diverse da quelle qui riportate.
2. Raccomandiamo ai nostri clienti di consultare sempre i nostri collaboratori tecnici-commerciali per richiedere informazioni specifiche in merito alle caratteristiche tecniche dei nostri prodotti.
3. Le raffigurazioni, tutte di valore generale e non vincolante, possono non corrispondere alle reali condizioni dei prodotti.
4. Bardiani Valvole S.p.A. si riserva in qualsiasi momento e senza preavviso di modificare e/o aggiornare i dati, i disegni e le informazioni riportate nel presente documento
5. Quanto riportato sulla presente pubblicazione si riferisce a prodotti di nostra normale produzione e non può in alcun caso essere un riferimento di base per prodotti eseguiti su specifiche richieste.
6. Bardiani Valvole S.p.A. non è responsabile per i vizi e/o i difetti derivanti da installazione del prodotto non in conformità a quanto indicato nel "Manuale di istruzioni uso e manutenzione" o comunque derivanti da installazione non corretta o impropria o da un uso non corretto e/o improprio del prodotto.
7. Bardiani Valvole S.p.A. non è responsabile per vizi e/o difetti del prodotto derivanti da un trasporto non corretto e/o derivanti da una impropria e/o non idonea conservazione e/o manutenzione dello stesso.
8. Bardiani Valvole S.p.A. non è responsabile per difetti e/o vizi del prodotto dovuti a manomissioni e/o a interventi effettuati da personale non qualificato professionalmente, così come non è responsabile per i danni provocati da urti, ammaccamenti, incuria, negligenza ed in genere cause non imputabili a difetti di costruzione, fabbricazione e difetti di materiale.

## Disclaimer

1. *All the statements, indications and technical data listed in this document are based on technical tests carried out by Bardiani Valvole S.p.A.. However accurate and reliable, such tests do not reflect all possible circumstances under which the products may be used. It is therefore advisable that the Buyer should always ascertain the suitability of the product in its application. The Buyer will be entirely liable for all risks and damages incurred by said products. Bardiani Valvole S.p.A. are not liable for any accident, loss or damage incurred, whether they be directly or indirectly caused by the use or misuse of the products. No further guarantees other than those stated in this document shall be granted.*
2. *All our customers are advised to consult our technicians as well as our offices who will supply all information pertaining the technical characteristics of our products.*
3. *The pictures contained in this document are intended to be general representations. They are not to be intended either legally binding or detailed representations of our products.*
4. *Bardiani Valvole S.p.A. reserve the right at any time and with no further notice to amend and up-date the technical data, designs and the information contained in this document.*
5. *The data and statements listed in this document only refer to our standard products. They do not apply in any case to any tailor-made products that might have been purchased by the customers.*
6. *Bardiani Valvole S.p.A. are not liable for any defects or faults resulting from the incorrect installation of their products. Such installation is to be carried out in full compliance with the instructions contained in the "Manual of Instructions for the Use and Maintenance of the Product". Bardiani Valvole S.p.A. are not liable for any defects or faults resulting from the incorrect use of their products.*
7. *Bardiani Valvole S.p.A. are not liable for any defects or faults resulting from the incorrect transportation and/or incorrect storage and/or incorrect maintenance of their products.*
8. *Bardiani Valvole S.p.A. cannot accept any liability for any faults or damages deriving from mishandling of the products and/or interventions carried out by unqualified personnel. No liability is accepted for damages caused by hits, dents, carelessness, negligence or any other any acts that cannot be considered as construction faults or faults related to the materials used in production.*



Bardiani Valvole s.p.a. via G. di Vittorio, 50-52, 43045 Fornovo di Taro (PR) Italy  
Tel +39.0525.400044 Fax +39.0525.3408  
e-mail: [bardiani@bardiani.com](mailto:bardiani@bardiani.com) [www.bardiani.com](http://www.bardiani.com)  
[www.bardiani.eu](http://www.bardiani.eu)  
I-CAT-FARF-0409

